

F34S1-x2xxxDx001

工業開關 > 金屬開關

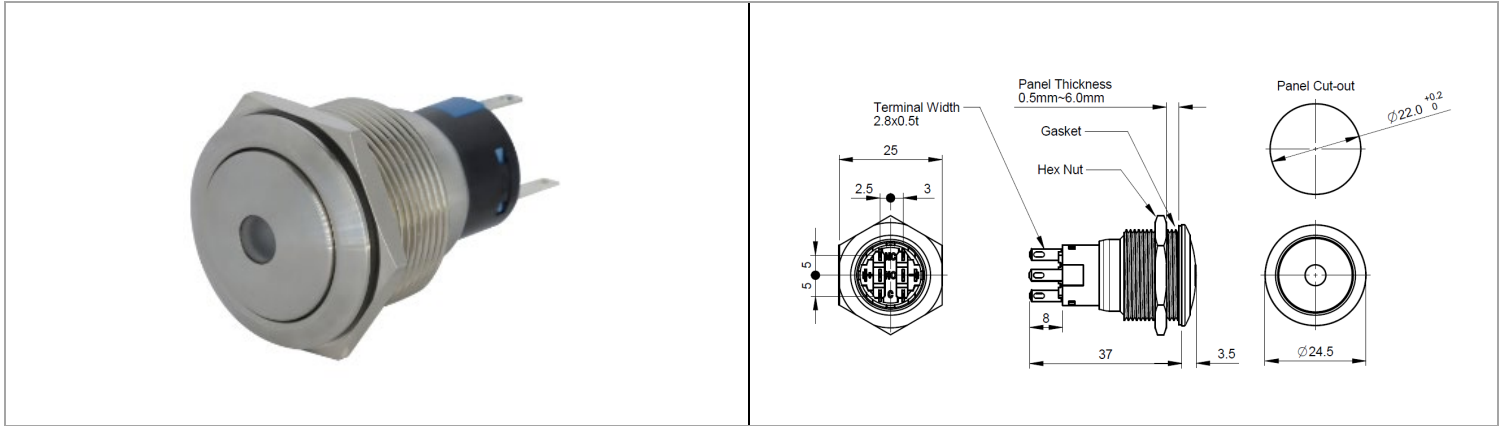

目錄僅供參考，實際規格仍依照產品工程圖面為準

產品介紹 Product Description

應用標準 Application Standards

UL(UL508,CSA-C22.2 No. 14)	
AC General	125V/5A / 250V/5A
AC resistance	125V/5A / 250V/5A
DC resistance	24V/1A / 125V/0.2A / 250V/0.1A
TÜV(EN60947-1:2007/A1:2011,EN60947-5-1:2004/A1:2009)	
AC-15	12V/5A / 30V/5A / 125V/3A / 250V/1.5A
DC-13	12V/1A / 30V/1A / 125V/0.22A / 250V/0.11A
IP	IP67
Pollution degree	2

F34S1-	<input type="checkbox"/>	<input type="checkbox"/>	<input type="checkbox"/>	<input type="checkbox"/>	<input type="checkbox"/>	<input type="checkbox"/>	<input type="checkbox"/>	<input type="checkbox"/>	<input type="checkbox"/>
Function	IP	Contacts	LED Voltage	LED Color	Actuator Options	Material Finish	Lens Color	Mark	
1: Momentary 2: Maintained	2:IP67	3: 1 NO+1 NC 4: 2 NO+2 NC	0: None 2: 6V 3: 12V 4: 24V	N: None G: Green R: Red A: Amber B: Blue W: White	F: Flush P: Prominent D: Domed	S: Stainless Steel P: Brushed Stainless Steel A: Aluminum B: Black Aluminum	0: None G: Green R: Red A: Amber B: Blue	00: None 01: Dot 02: Ring	

技術規格 Technical Data

Dielectric Strength	Between live part and ground: 2,000V AC, 1 min. Between terminals of the same poles: 1,000V AC, 1 min.
Contact Resistance	50 mΩ maximum (initial value)
Insulation Resistance	100 MΩ minimum
Operating Humidity	45 to 85% RH (no condensation)
Storage Temperature	- 30 to +80°C (no freezing)
Operating Temperature	- 25 to +50°C (no freezing)
LED Operating Temperature	-25 to +55°C (no freezing)
Vibration Resistance	Operating extremes/Damage limits: 5 to 55 Hz, amplitude 0.5 mm
Shock Resistance	Damage limits: 500 m/s ² Operating extremes: 200 m/s ²
Mechanical Life	Momentary: 1,000,000 Maintained: 100,000
Electrical Life	50,000
Terminal Style	Solder terminal
Button travel (nominal)	2.8mm
Torque (max)	3.5Nm
Operating Force (nominal)	For 1NO1NC: 2 N For 2NO2NC: 3 N
Weight (approx.)	33g/20g (Stainless Steel/Aluminum)